

# Cleanroom

C a t a l o g u e



# Industries we serve

- Sterile
- Oncology
- OSD
- LVP/ SVP
- Injectable
- API
- Biotechnology
- R&D Lab

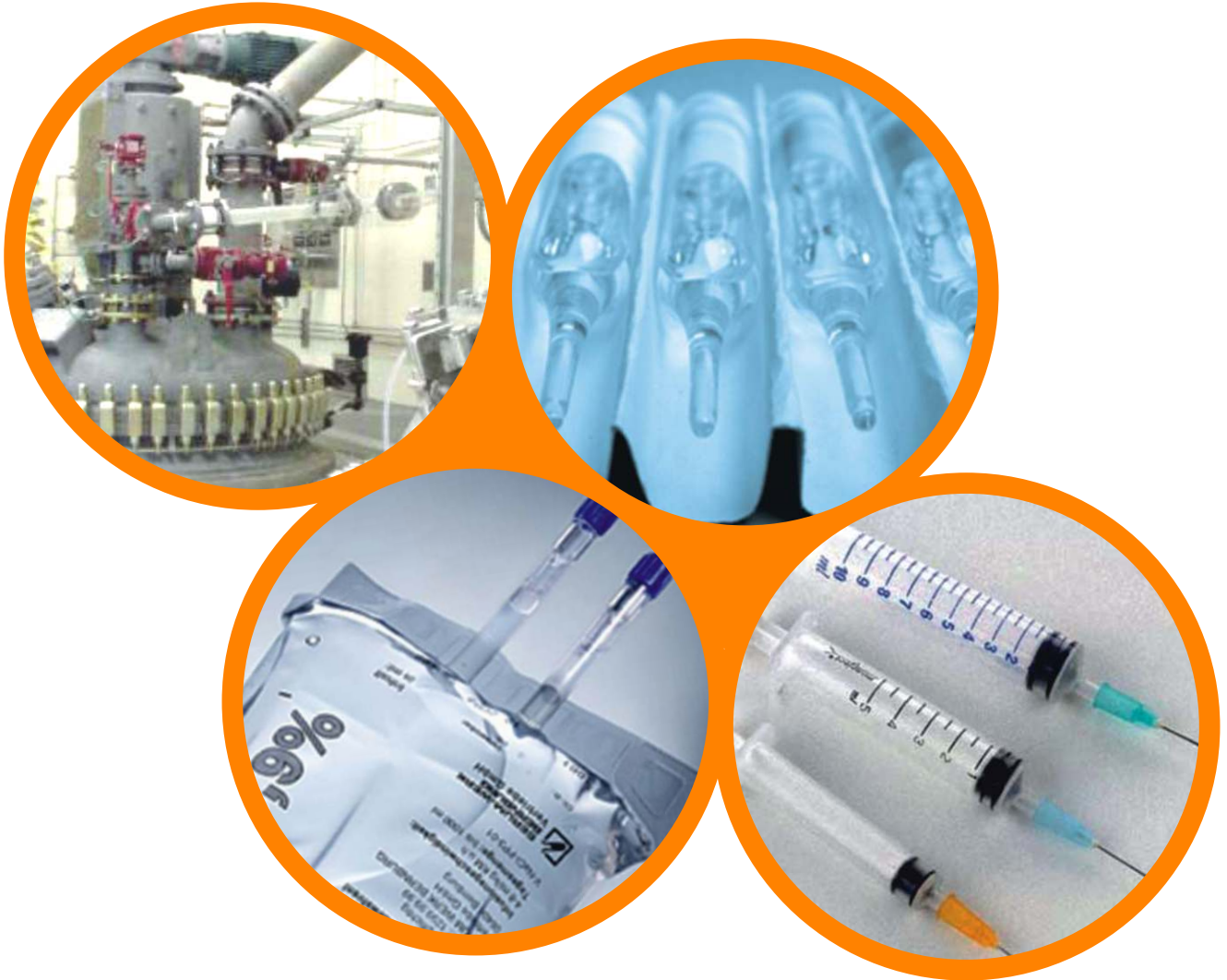

Our Modular Cleanroom partitioning system is designed for ease in installation and practical functionality, while maintaining a modular flexibility. Simplified construction methods and progressive & non-progressive systems help our client's to minimize overall construction time.

## OUR PRODUCT LINE

- Pre-engineered powder-coated modular panels
- Pre-painted modular panels
- Cleanroom Metal Doors
- Fire Rated Metal Doors

- Veterinary
- Healthcare
- Medical devices
- Food and beverages
- Semiconductor
- Solar panels
- Electronics
- Glass manufacturing



## Why Us

- Team having a rich pharmaceutical experience
- Ability to understand customer's requirements
- Tailor made products
- Own installation team ensuring timely project completion
- Products in compliance with the regulatory requirements
- Latest updated technology as per current industrial needs



# Turnkey Cleanroom Solutions

## Cleanroom Modular Wall & Ceiling Panels

### Cleanroom Doors & Windows



### Cleanroom HVAC & Validation



### Cleanroom Equipment



### Cleanroom Electrical & Utilities







# GI Powder Coated Cleanrooms

GMP modular panels are made up of GPSP GI sheet having lock formed quality (LFQ), minimal spangle with a zinc coating of 80-120 gsm. The panels are filled with an infill of polyurethane foam (PUF/ PIR), honeycomb paper core or high density mineral wool.



**SBRG Clean Tech** modular panels are pure polyester powder coated to 60-80 microns and 15-25% gloss level with below properties

- Inert and non particle shedding
- Resistance to abrasion and chemicals
- Thermal and sound insulation
- Corrosion protection
- Smooth bump free surface
- Better UV protection
- Easy cleaning and maintenance



Panel Width: 1205 mm, 1220 mm as standard

Panel Thickness: 50, 80, 100 mm as standard

Panel Height: up to 6000 mm with provision of stacked panels for higher applications

Panel connection: Friction type interlocking key for Speedy & Dismantling.

- Base Detail** : Raised type base to allow flush coved finish and C-type base
- View panel** : Viewing glass is an integral part of wall panel thus called view panel. It is made up of 5mm thick toughened glass duly flushed on both sides of wall panel
- Door** : Lock formed construction. Optional double and single glazed view with cleanroom compatible accessories
- Coving** : Powder coated aluminium coving. Press fit fixing arrangement with aluminium backing
- Return air -risers** : Return air riser is an integral part of wall panel. It is made by fabricating a duct of maximum 900 mm width in between panel and given 150 mm above ceiling projection. Perforated grill in powder coated GI or in SS 304 is also provided.
- Ceiling panel** : Walkable and non-walkable ceiling panels are made up of same method as wall panel but with stiffeners for additional strength
- Cutouts** : Factory made cutouts are provided as per required sizes and location with GI conduit for running cables. Ceiling cutouts could be with lip or without lip as per required design
- Sealant** : Food grade silicone sealant for minimizing air leakages



# Return Air Riser Panels

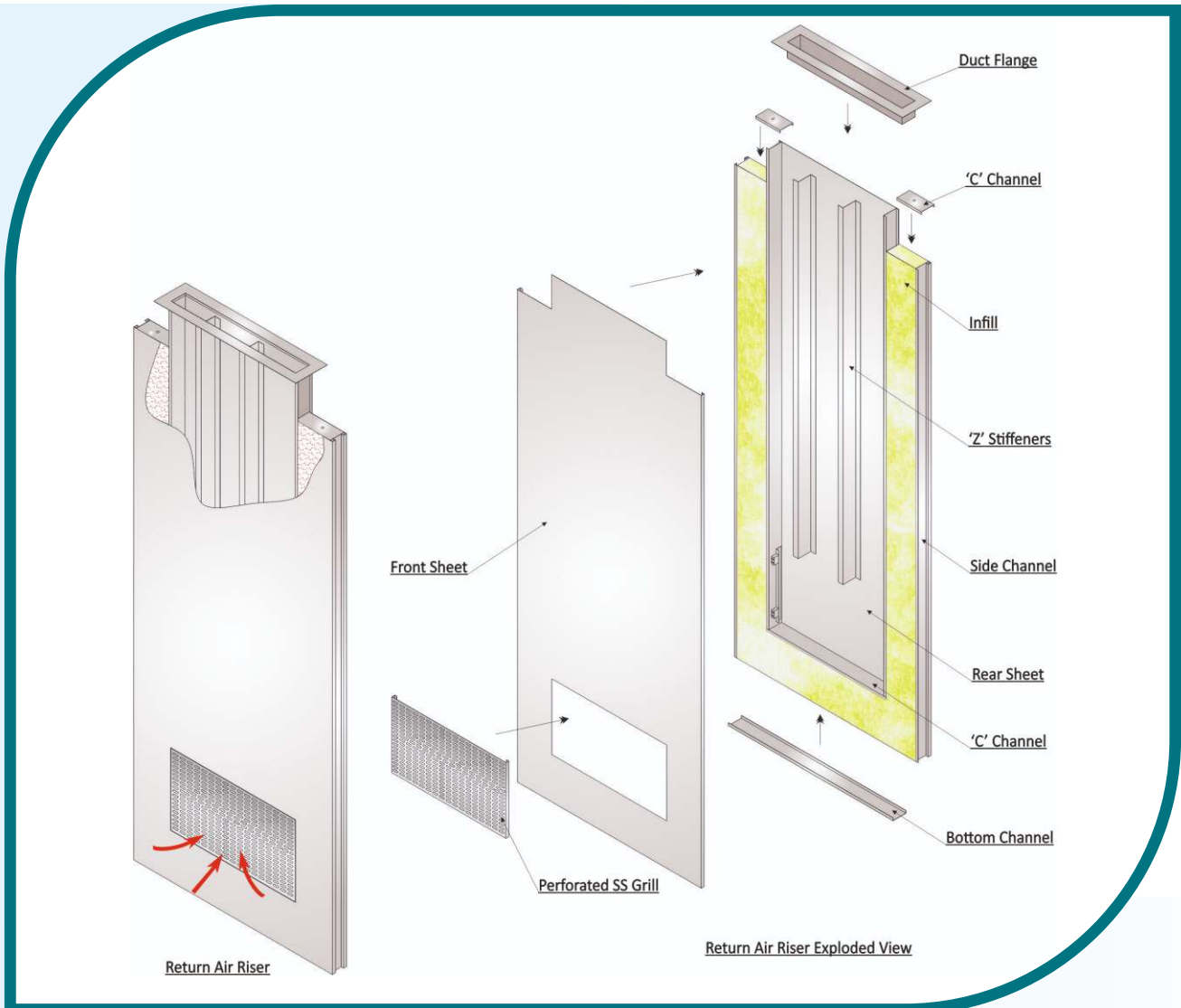

We are manufacturing Return Air Rise panels. These panels have integrated suction area in modular panel which is developed to ensure leak proof installation. Our range of return air risers is extensively applied to overall appearances of cleaned rooms. Further, our range is renowned for high-end features such as corrosion resistance, curved corner at bottom and low maintenance. These panels are concealed Type, SS, GL/ CRCA Powder coated construction, with/ without front doors.

These panels have provision for installing of VCD for flow control. The Upper flange is for connection in ducts, calculated cutouts for suction area. It is Available with Grill, VCD, Filter, Filter sheets.

# Fire Retardant wall Panels



Fire Retardant panels consist of two outer metal sheets (steel or aluminium) with an insulation of puff core sandwiched, bonded with specialized adhesives. This system setup provides outstanding mechanical performance at minimal weight. The excellent performance of rock wool insulation is commonly adopted for fire-resistance and noise reduction in buildings. Fire retardation capacity 350 to 750°C with 2 hours of fire rating.

# Pre-Painted GI Cleanrooms (PPGI)



Pre-painted wall and ceiling panels are fabricated by using pre-painted GI Sheets of 0.60/0.80 mm thickness. These are bonded on GI frame with an in-fill of polyurethane foam (PUF/ PIR) forming a rigid panel.

- Standard thickness: 50, 80 and 100 mm
- Standard width: 1000/1200 mm
- Standard height: 3000 to max. 6000 mm
- Base Detail: C-Type base
- Panel connection: Friction type interlocking key for speedy erection and dismantling
- Cutouts: On site cutouts of required sizes





## FEATURES

- Maximum durability and high visibility
- Attractive look
- Prevents direct contact with sunlight
- High energy saving

## Specifications

View Panels are similar as wall panels with cutout for vision. In view Panel in which 5 mm toughened glass is flushed with the both skins of partition.

– It has moisture-absorbing silica-gel granules along with the SS/GI/ALU frame to keep the glazing unit cavity moisture-free.

<b>Standard size</b>	: 1200 X 4500 mm
<b>Base Detail</b>	: Raised type base to allow flush coved finish and C-type base
<b>Panel connection</b>	: Friction type interlocking key for speedy erection and dismantling
<b>Insulation</b>	: Polyurethane foam (PUF/ PIR), paper core honeycomb and mineral wool
<b>Surface Finish</b>	: Glossy finish available in various colors
<b>Coving</b>	: Powder coated aluminium coving. Press fit fixing arrangement with aluminium backing
<b>Sealant</b>	: Food grade silicone sealant for minimizing air leakages

# Load Bearing Ceiling



The unique design of the ceiling allows the additional in incorporating flush light fittings, air-conditioning filters, grills, diffusers and other ceiling mounted equipment, all fitted within accurately CNC punched apertures. Its unique design enables the structure to stand free of any support (box within a box) from the existing building/ structure.

## Technical Specification

Technical Specification	PCGI (Powder Coated)	SS	HPL	GRP	PPGI (Pre-Painted)
Skin	0.6/ 0.8/ 1.0 mm	0.8/ 1.0 mm	3.0/ 4.0 mm	4.0 mm	0.6 mm
Structural Frame Work	GI	GI	Aluminium	GRP in wall Aluminium in celing	GI
Insulation	PUF/ PIR/ Rockwool/ Papercore	PUF/ PIR/ Rockwool/ Papercore	PUF/ PIR/ Rockwool/ Papercore	Nil	PUF/ PIR
Connecting Profile	AL/ GI	AL/ GI	AL	GI	AL
Base Profile	GI Raised Floor Track U Type	SS/ GI Raised Floor Track U Type	GI Raised Floor Track U Type	GRP	GI (U Type)
Sealant	Silicon Sealant	Silicon Sealant	Silicon Sealant	Silicon Sealant	Silicon Sealant
Panel Width	1120 mm	1120 mm	1200 mm	961 mm	1000 mm
Panel Height (Maximum)	6000 mm	6000 mm	4500 mm	4500 mm	3000 mm
Panel Thickness	80/100/160 mm	80/100/160 mm	80/100/160 mm	80/100/160 mm	80/100/160 mm
Power Coating Thickness	60-80 Micron	NA	NA	NA	25-30 Micron
Finish	Matt Finish	SS Finish (Matt/ Mirror Finish)	Laminated	Matt finish	Gloss finish (40% Gloss level)
Color	As Per GMP Ral Chart	NA	As Per Shade Card	Various	9002
Coving (AL Power Coated)	R50	R50	R50	Inbuilt in Panel	R50

# Cleanroom Panel Accessories

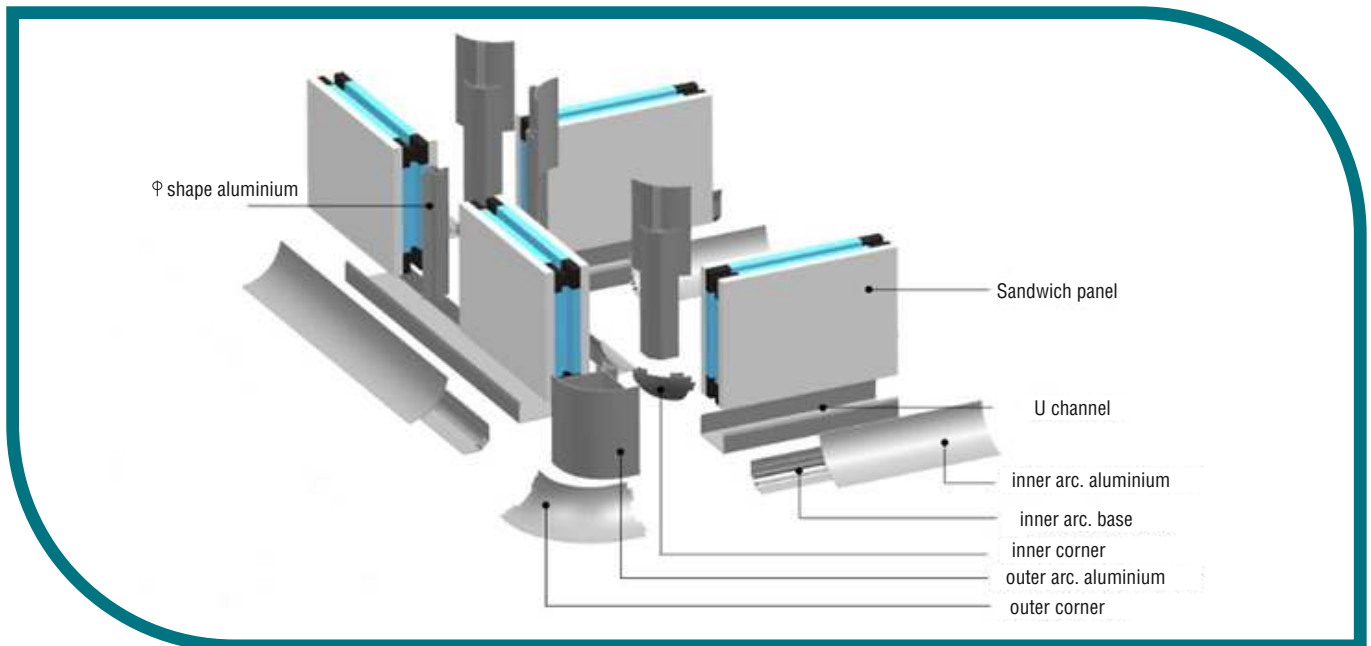

Name: Aluminium  
Thickness: 1.5 mm / 2.0 mm / 2.5 mm



Name: Aluminium  
Thickness: 0.8 mm / 1.0 mm / 1.2 mm

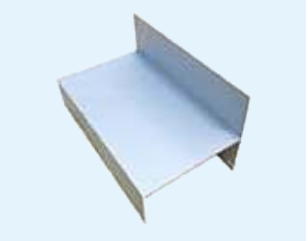

Name: Outside Cylindrical  
Thickness: 0.8 mm / 1.0 mm / 1.2 mm

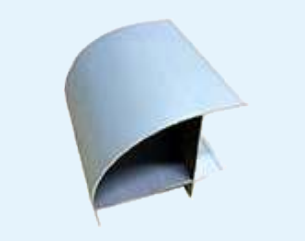

Name: Aluminium Tube  
Thickness: 0.8 mm / 1.0 mm / 1.5 mm

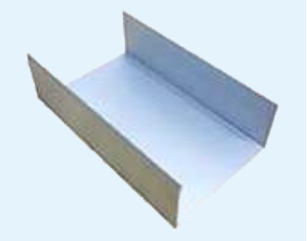

Name: Aluminium Tube  
Thickness: 0.8 mm / 1.0 mm / 1.5 mm

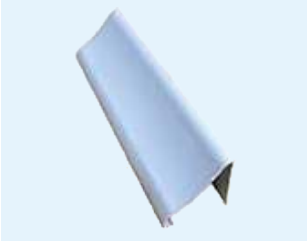

Name: Inner Arc  
Thickness: 0.8 mm / 1.0 mm

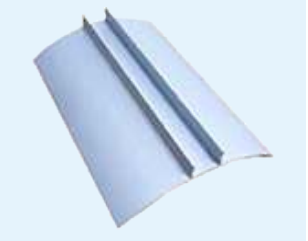

Name: Double Door Material  
Thickness: 1.0 mm / 1.2 mm / 1.5 mm

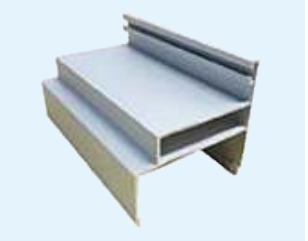

Name: Single Door Material  
Thickness: 0.8 mm / 1.0 mm / 1.2 mm



Name: Window Material  
Thickness: 0.8 mm / 1.0 mm / 1.5 mm

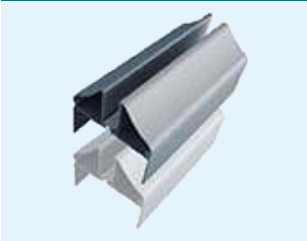

Name: Window Material  
Thickness: 0.8 mm / 1.0 mm / 1.5 mm

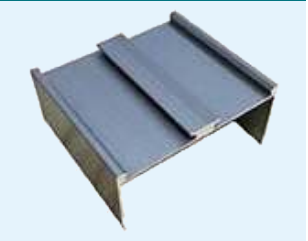

Name: Hanging Beam  
Thickness: 1.0 mm / 1.5 mm / 2.0 mm



Name: Single Door Material  
Thickness: 0.8 mm / 1.0 mm / 1.2 mm

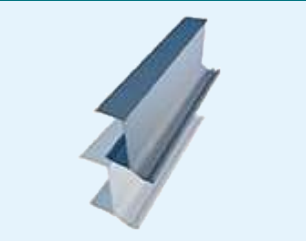



# Metal Doorsets

- FIRE RATED DOOR
- CLEAN ROOM DOOR
- INDUSTRIAL DOOR
- ACOUSTIC DOOR



Doorsets are specifically tailored to critical requirements of the market with special attention to the use of galvanized/stainless steel. GMP metal doorsets are available in different configurations to achieve varying requirements of our clients. In addition to single leaf and double leaf frames with removable over panels, borrowed light and glazing can be introduced.

## **FIRE RATED DOOR**

Fire Rated Door with fire resistance rating used as part of a passive fire protection system to reduce the spread of fire between compartments and to enable safe egress from a building or structure. GMP offers fire rated doors with fire resistant levels from 30 minutes to 2 hours all tested to BS 476 Part 22, UL10B & UL 10C.

## **CLEAN ROOM DOOR**

Cleanroom Door is manufactured from galvanized steel/stainless steel sheets with lock formed edges. Insulated and bonded with honeycomb paper, mineral wool or polyurethane foam forming a rigid flush fittings with innovative flush double glazed finished in pure polyester coating of 60-80 microns forming smooth surface finish.

## **INDUSTRIAL DOOR**

Heavy duty industrial metal doorsets are available in size up to 3000 mm width and 3500 mm in height. Doors are capable of accepting glazing in many configurations with air vents, louvers and a wide range of hardware. Doors are pure polyester powder coated to 60-80 microns forming a smooth surface finish.

## **ACOUSTIC DOOR**

Acoustic Door is designed to reduced sound transmission between rooms and to provide sound privacy if any architectural environment. GMP offers acoustic door with special linings, seals and structurally bonded cores to achieve high level of sound reduction.

# METALLIC FLUSH DOORS FOR CLEAN ROOM, LABS MADE OUT OF POWDER COATED GALVANIZED SHEETS OR STAINLESS STEEL



Doors for long life, pressurized rooms, security, Sensor operated and for aesthetics.

With in fill of Paper Honey Comb and enclosures of steel sheet make it not only look good but gives strength and light weight.

Ideal for industries and the places where there is frequent usage.

## Unique selling points

- Being metallic in nature, we can create a air tight configuration thus perfect for clean room applications.
- Specialized PU paints are used for ever lasting and scratch resistance qualities.
- High end accessories like Door closures, Handles, Hinges, Kick plates, Tower bolts etc.
- Available in Stainless steel also for chemical applications and for corrosive environment.
- Single & Double Shutter.

## APPLICATIONS :

Clean Rooms, Labs & Hospitals, Building-High Rise And General, Industries In General



## SPECIFICATIONS:

<b>Door Jamb</b> Size : 50 mm, 60 mm, 80 mm and 100 mm Material : Gpsp/Stainless steel Sheet thickness: 1.2 mm Frame Profile : Single Rebate	<b>Door Leaf</b> Thickness : 46 mm Material : Gpsp/Stainless steel Sheet thickness: 0.8 mm and 1 mm Infill : Puf, Honeycomb and Rockwool
<b>Vision Panel</b> Size : Optional (As per client requirement.) Type : Flush double Glass (Float/Toughned)	<b>Finish</b> Powder Coating( 60 to 70 micron) Stainless steel
<b>Hardware</b> Chempharm standard hardware and optional (Dorma/Stainley/Geze/IR)	<b>Fixing Arrangement</b> Anchor bolt, Fischer and Hex head screw
<b>Door size</b> <b>Std size for single door</b> 750 X 2100 mm 900 X 2100 mm 1000 X 2100 mm 1100 X 2100 mm Non std as per client requirement	<b>Std size for double door</b> 1200 X 2100 mm 1500 X 2100 mm 1800 X 2100 mm 2000 X 2100 mm 2200 X 2100 mm Non std as per client requirement

Mineral Wool



Honeycomb



PUF



# Fire Rated Doors & Emergency Exit Doors

## IT IS BETTER TO BE SAFE THAN SORRY

Our Fire Doors are tested as per BS 476 Part 22 and IS 3614 Part 2 for stability and integrity. They are available in an extensive range from half an hour fire rating to 2 hours fire rating.

Highly trained team from designs with most experienced manpower and with the use of high end machines brings the doors which – Keeps the security need in mind and aesthetic properties as well

## OUR UNIQUE SELLING POINTS

- Fire rating up-to 2 hours
- Duly certified from reputed labs of india
- Specialized scratch resistant paint for high temperature
- Manufactured from high end steel fabrication machines using Laser/Turret/CNC bends etc.
- Smooth finish with high quality infill & fittings
- Recommended for high rise building, chemical plants, general industries, telecom & IT/Software companies for server rooms etc, electronic companies auditorium, multiplexes.
- **Optional Accessories -**
- **Anti-Panic Exit Device (Panic Bars):**
- **Externally fitted Door Closers:** Heavy duty door closers available in various makes and TYPES like fire rated and non-fire rated.
- **Vision Panel:** Available in Wired & Clear glass (Rectangular/ square)
- **Externally fitted Hardware Fittings** like Locks/Handles/Tower Bolts/Latches etc.
- **Provision for Access Control.**



## TECHNICAL SPECIFICATIONS

### Door Jamb

Size	: 100 mm, 125 mm and 150 mm
Material	: Gpsp/Stainless steel
Sheet thickness	: 1.5 mm
Frame Profile	: Single Rebate and Double Rebate

### View Glass

Size	: 9 sqm (based on certification)
Type	: Single view Panel - Fire rated, Toughened and float glass (optional)

### Hardware

Chempharm standard hardware and optional (Dorma/ Stainley /Geze/IR)

### Certification

CBRI- Apply(BS 476 part 22)

### Std size for double door

1200 X 2100 mm
1500 X 2100 mm
1800 X 2100 mm
2000 X 2100 mm
2200 X 2100 mm

Non std as per client requirement

### Door Leaf

Thickness	: 44 mm/46 mm
Material	: Gpsp/Stainless steel
Sheet thickness	: 1mm
Infill	: Honeycomb and Rockwool

### Finish

Powder Coating( 60 to 70 micron)
Stainless steel

### Fixing Arrangement

Anchor bolt and Hex head screw

### Std size for single door

750 X 2100 mm
900 X 2100 mm
1000 X 2100 mm
1100 X 2100 mm

Non std as per client requirement

# Sliding Doors For OT - Hospitals & Labs

Hermetically Sealed Sliding doors or Non Hermetically Sealed are manufactured in house for critical application

## USP (Unique Selling Proposition)

- Stainless steel & Powder coated
- Door Movements/Drives are Imported
- Sealing are used as per international standard
- Duly tested after installation for leakages
- Sensor operated - Foot Sensor & Hand Sensor
- Ultra Finish in both Stainless steel as well as powder coated

## SPECIFICATION:-

1. **Door panel**  
**Material-** SS sheet or GPSP  
**Thickness-** 0.8mm or 1 mm
2. **Jamb**  
**Material-** SS sheet, Gpsp  
**Thickness-** 1.2 mm
3. **Door size**  
A. Single sliding doors- 800 mm to 1500 mm X 2000 mm to 2400 mm  
B. Double sliding doors- 1500 mm to 2400 mm X 2000 mm to 2400 mm
4. **Finish** - SS 304 brush finish and powder coating



## COLD ROOM / COLD STORAGE AND FREEZER DOOR

Such doors are made out of PCGI sheet with special fittings and thickness from 60 mm to 150 mm.

The doors are fitted with low temperature gaskets. The sizes and colors are to suit the end users





# Door Design



S (Solid)

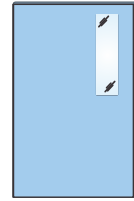

SNV (Short-Narrow Vision)

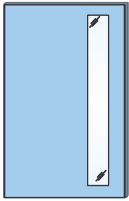

Stand View Panel

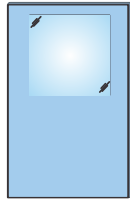

HG (Half Glass)

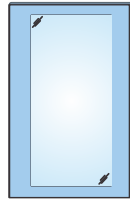

FFG (Full Face Glass)

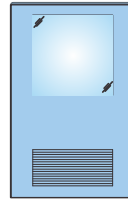

HGL (Half Glass Louver)

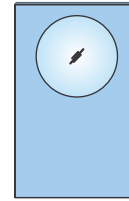

CV (Circular Vision)

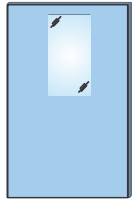

CR (Clear Room)

## Ironmongery



DEAD LOCK



D HANDLE



HINGE



FLUSH BOLT



DOOR SEAL



DOOR CLOSER

## Door Handling



LH LEFT HAND



RH RIGHT HAND



DDLA DOUBLE DOOR LEFT ACTIVE



DDLA DOUBLE DOOR RIGHT ACTIVE

## Frame Profile For Brick Work



6 bends single rebate profile for fire and non-fire rated system



6 bends single rebate profile for Non-fire rated system



8 bends double rebate profile for fire rated and non-fire rated system

## Frame Profile For Partition

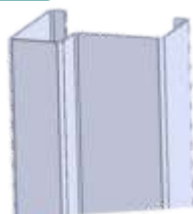

80 mm Profile

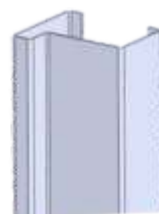

60 mm Profile

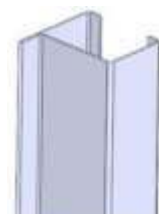

50 mm Profile

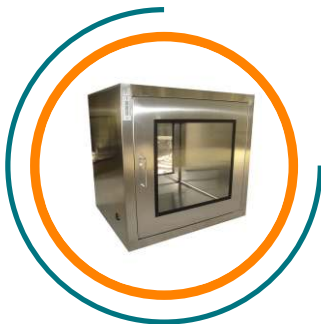

**PASS BOX**



**AIR FLOW UNIT**



**AIR SHOWER**



**MIST SHOWER**



**BIO-SAFETY  
CABINET**



**DISPENSING &  
SAMPLING BOOTHS**

## Static Pass Box

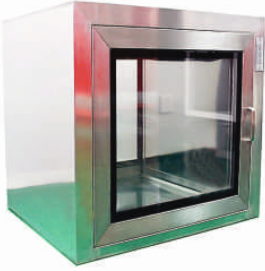

**SBRG** Static Pass Box is specifically designed that aids in the material transfer within same Cleanroom Classification without much personnel movement.

### SPECIFICATIONS & FEATURES

- Material of Construction : SS 304 / SS 316 / SS 316 L / PCGI
- Flush Double walled Construction with Internal Coving
- Flush Doors with double walled flush glass view panels
- Electro-Magnetic Interlocking / Mechanical
- Feather touch Door Release Switch on either side

**SBRG** Dynamic Pass box helps in prevention of contaminants entrance either in the Cleanroom or between various classified areas.

### SPECIFICATIONS & FEATURES

Material of Construction	:	SS 304 / SS 316 / SS 316 L / PCGI
Air cleanliness	:	ISO Class 5 (ISO 14644-1:1999(E))
Air Velocities	:	0.45 ± 0.05 MPS OR 100 ± 20 FPM
Air Flow	:	Vertical – Re-circulatory
Power Supply	:	230V AC 1- Ø 50 HZ

## Dynamic Pass Box



## Horizontal LAF



**SBRG** Horizontal LAF is designed for offering highest product protection by providing ISO Class 5 particle free work area for handling critical process.

### SPECIFICATIONS & FEATURES

Material of Construction	:	SS 304 / SS 316 / SS 316 L / PCGI
Air cleanliness	:	ISO Class 5 (ISO 14644-1:1999 (E))
Air Velocities	:	0.45 ± 0.05 MPS OR 100 ± 20 FPM
Air Flow Direction	:	Horizontal – Re-circulatory
Power Supply	:	230V AC 1- Ø 50 HZ
Supply Filter	:	HEPA Filter - Efficiency- 99.997% down to 0.3

**SBRG** (RLAF) is designed for providing highest level of protection from airborne contaminants generated during powder handling operations such as sampling, charging & dispensing. RLAF provides Operator Protection & Product Protection

### SPECIFICATIONS & FEATURES

Material of Construction	:	SS 304 / SS 316 / SS 316 L / PCGI
Air cleanliness	:	ISO Class 5 (ISO 14644-1:1999 (E))
Filtration Stages	:	3 Stage Filtration
Air Velocities	:	0.45 ± 0.05 MPS OR 100 ± 20 FPM
Supply & Bleed Filter	:	HEPA Filter - Efficiency- 99.997% down to 0.3 micron

## Reverse LAF



## Vertical LAF



**SBRG** Vertical LAF is designed to create areas supplied with a continuous flow of clean air to maintain a work environment that is free from dust particles, and toxic or noxious fumes.



### SPECIFICATIONS & FEATURES

Material of Construction	:	SS 304 / SS 316 / SS 316 L / PCGI
Air cleanliness	:	ISO Class 5 (ISO 14644-1:1999 (E))
Air Velocities	:	0.45 ± 0.05 MPS OR 100 ± 20 FPM
Air Flow Direction	:	Vertical – Re-circulatory
Power Supply	:	230V AC 1- Ø 50 HZ
Supply Filter	:	HEPA Filter - Efficiency- 99.997% down to 0.3 micron

**SBRG** (MLAF) is designed for transporting sterile products under Class 100 particle free work area. The work area is supplied with positive pressure HEPA filtered air flow.

## Mobile LAF Trolley



### SPECIFICATIONS & FEATURES

Material of Construction	:	SS 304 / SS 316 / SS 316 L / PCGI
Air cleanliness	:	ISO Class 5 (ISO 14644-1:1999 (E))
Filtration Stages	:	2 Stage Filtration
Air Velocities	:	0.45 ± 0.05 MPS OR 100 ± 20 FPM
Power in Mobility	:	Battery back-up with inverter for 30 minutes
Supply Filter	:	HEPA Filter - Efficiency- 99.997% down to 0.3 micron

## Air Shower



**SBRG** Air Shower is designed to supply Class 100 HEPA filtered air at high velocity to remove particulate matter from the person entering the Cleanroom.

### SPECIFICATIONS & FEATURES

Material of Construction	:	SS 304 / SS 316 / SS 316 L / PCGI
Air Velocities	:	2500 to 4000 FPM
Air Flow Direction	:	Vertical + Horizontal through Jet Nozzles
Power Supply	:	230 V AC 1 Ø 50 HZ / 415 V AC 3 Ø 50 HZ
Supply Filter	:	HEPA Filter - Efficiency- 99.997% down to 0.3 micron

**SBRG** Mist Shower (MS) is a chamber installed at exit of Cleanroom to provide protection during de-gowning process while exiting the area.

## Mist Shower



### SPECIFICATIONS & FEATURES

Material of Construction	:	SS 304 / SS 316 / SS 316 L
Mist Flow Direction	:	Vertical + Horizontal through Mist Nozzles
Supply & Drain System	:	Supply & Drain system with Ultrasonic Nozzles
Control Systems	:	PLC / Micro- processor-based Controller
Flooring Type	:	Removable Stainless-Steel Flooring



## Bio Safety Cabinet



**SBRG** (BSC) is designed to provide personnel, environmental and product protection. Air flow is drawn around the operator into the front grille, which provides personal protection.

### SPECIFICATIONS & FEATURES

Material of Construction	:	SS 304 / SS 316 / SS 316 L / PCGI
Level of Safety	:	Level 1 to Level 3
Air cleanliness	:	ISO Class 5 (ISO 14644-1:1999 (E))
Air Velocities	:	0.45 ± 0.05 MPS OR 100 ± 20 FPM
Power Supply	:	230V AC 1- Ø 50 HZ
Supply & Exhaust Filter	:	HEPA Filter - Efficiency- 99.997% down to 0.3 micron

**SBRG** Garment Storage Cabinet (GSC) is designed to provide Class 100 particle free work area to meet garment storage needs which avoids any particulate accumulation.

## Garment Cubicle



### SPECIFICATIONS & FEATURES

Material of Construction	:	SS 304 / SS 316 / SS 316 L / PCGI
Air cleanliness	:	ISO Class 5 (ISO 14644-1:1999 (E))
Air Velocities	:	0.45 ± 0.05 MPS OR 100 ± 20 FPM
Air Flow Direction	:	Vertical – Re-circulatory
Supply Filter	:	HEPA Filter - Efficiency- 99.997% down to 0.3 micron

## Fume Hood



**SBRG** Fume Hood (FH) is a type of local ventilation device that is designed to limit exposure to hazardous or toxic fumes, vapors or dusts.

### SPECIFICATIONS & FEATURES

Material of Construction	:	Powder Coated MS / SS 304 / PCGI
Exhaust System	:	Exhaust Chimney with weather cowl, bends flanges.
Ducting	:	PVC / FRP duct pipe with suitable elbow
Power Supply	:	230V AC 1- Ø 50 HZ
Exhaust Filter	:	HEPA Filter - Efficiency- 99.997% down to 0.3 micron

Cleanrooms require specialized furniture that does not shed particles. You can rely on SBRG Clean Tech to supply the CLEANROOM furniture you need.

## SS Furniture

### SPECIFICATIONS & FEATURES

- Stainless Steel 304 Grade compatible with CLEANROOM Class 100,000 to Class 100
- Extremely smooth surface ensuring reduced particle retention

### Our Cleanroom SS Furniture range includes

- Stainless Steel Tables, Chairs, Trolleys, Step Ladders, Storage Lockers, Stools,
- Stainless Steel Cross Over Benches, Garment Storage Cabinets, Working Tables.
- Stainless Steel Racks, Trays, Mopping Trolleys, Bins, Sinks etc.





## Scope of Work in HVAC

- Complete HVAC High Side & Low Side works
- Hygiene AHU / Chillers
- Ducting as per SMACNA Standards
- Indoor Air Quality Control
- Humidity & Temperature Control & Monitoring
- Humidification & De-Humidification
- Ventilation Works
- Supply all Air Handling Unit



Plot No-104, Industrial Estate, Halol-2, Gujarat, India

Contact us: +91 8378998344 | +91 9691171225

Email: [info@sbrgcleantech.in](mailto:info@sbrgcleantech.in) | [regulatory@sbrgcleantech.in](mailto:regulatory@sbrgcleantech.in)

#### OUR BRANCHES

**FARIDABAD OFFICE**  
13, NIT, Industrial Area,  
Faridabad-121001, Haryana, India

**CORPORATE OFFICE**  
Plot No 30 Sector 33 Near Hero Honda  
Factory Gurgaon- 122001(Haryana) India

**DELHI HEAD OFFICE**  
2nd Floor, C-64, Lajpat Nagar-1,  
New Delhi-110024, India

[www.sbrgcleantech.com](http://www.sbrgcleantech.com)